













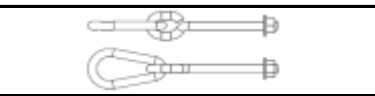

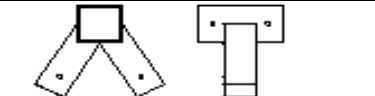
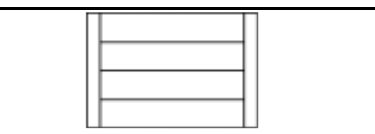

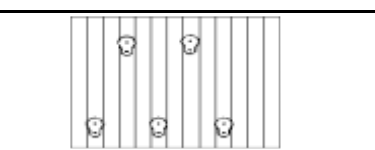

23		Rutsche		1
24		Schaukel Balken	90x90x2380	1
25		Schaukel Fuß	70x70x2390	2
26		Verbindungselement für Schaukel Füße	45x35x1730	1
27		Schlingseil für Schaukel		5
28		Metallbeschläge		1
29		Metallbeschläge		1
30		Verstärkungsplatte	500x360	2
31		Schaukel		2
32		Kletterwand	1415x750	1
33		Strickleiter		1
34			90x20x400	4
A		Holzschraube	6x120	12
B		Holzschraube	4x70	44
C		Holzschraube	3,5x50	20
D		Holzschraube	3x40	99
E		Holzschraube	3x30	18
F		Holzschraube	5x30	2
G		Holzschraube	3x16	12
H		Schraube + Mutter		8
I		Schraube + Mutter		8







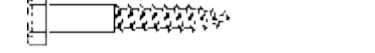
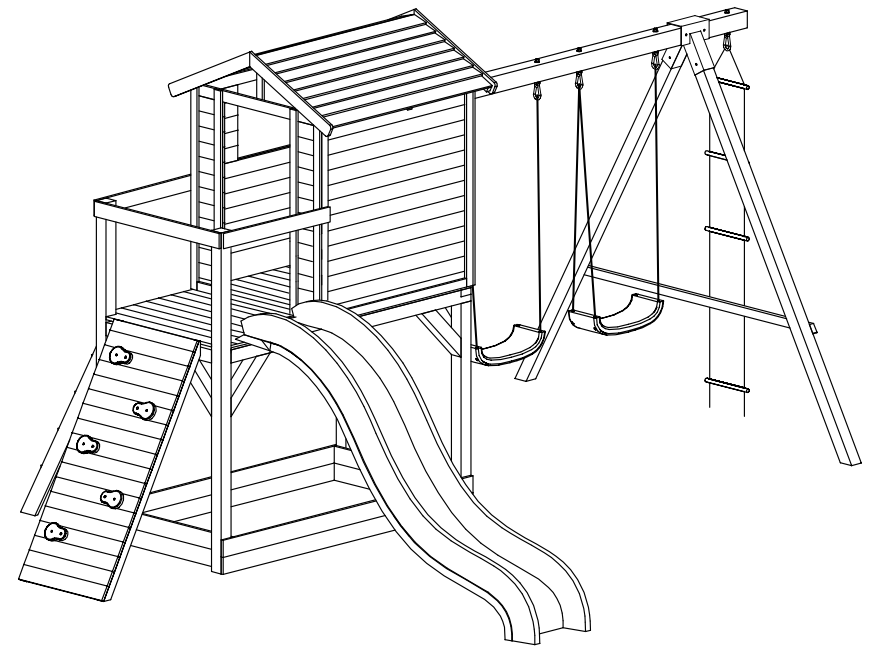
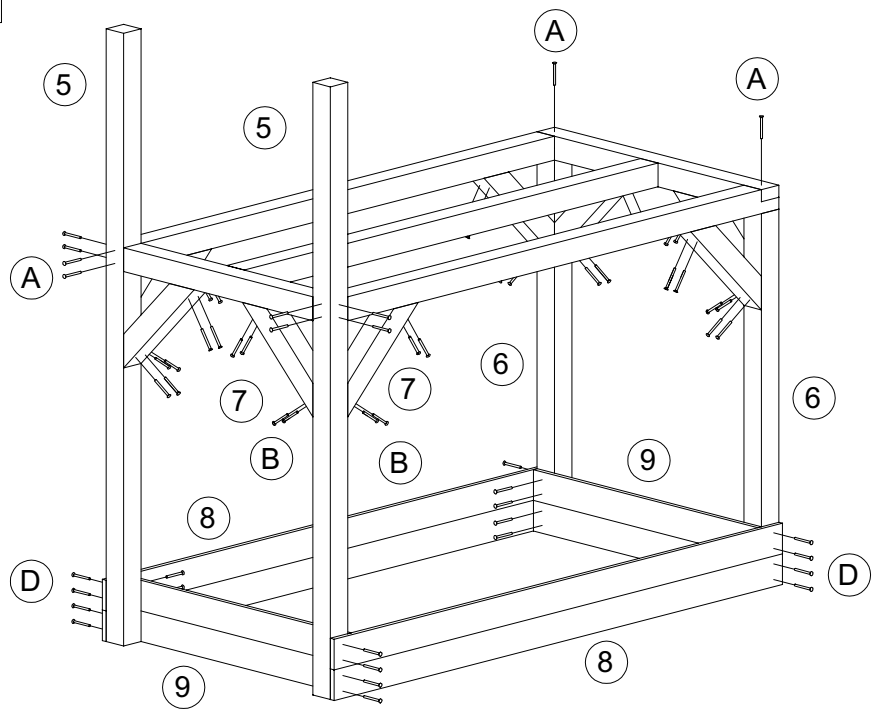
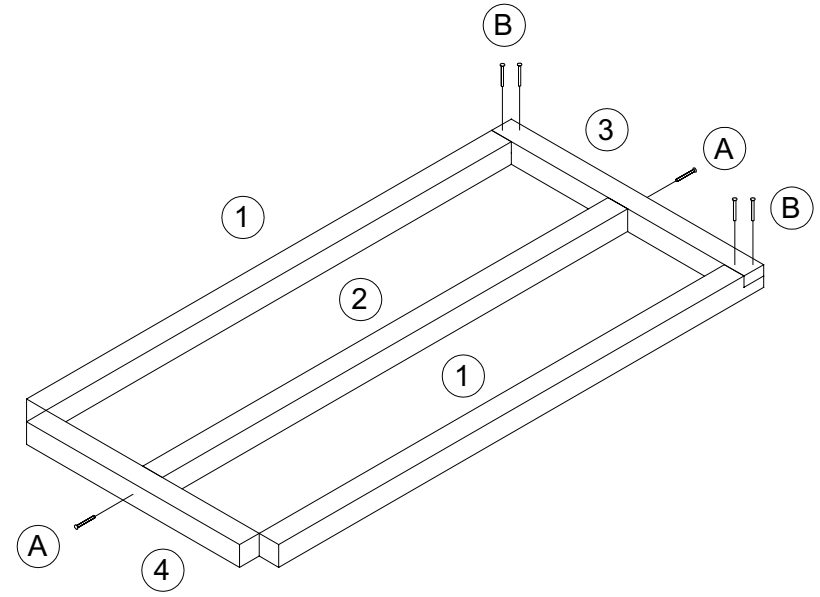



Stelzenhaus Matteo



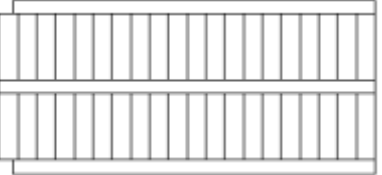
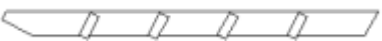

14		Seitenwand	1090x1100	1
15		Rückwand	1090x930	1
16		Vorderwand	1075x930	1
17		Dachfirst	35x35x1120	1
18		Dachfrist Stütze	40x15x250	2
19		Dachplatte	1190x620	2
20		Geländer Brett	70x15x750	2
21		Geländer Brett	70x15x900	1
22		Windträger	70x15x660	4

Liste der Materialien

Nr.		Name	Größe	Anzahl
1		Sockelbalken	70x70x1730	2
2		Sockelbalken	70x70x1660	1
3		Sockelbalken	70x70x900	1
4		Sockelbalken	70x70x760	1
5		Mast vorne	70x70x1800	2
6		Mast hinten	70x70x1100	2
7		Strebe	70x70x400	8
8		Sandkastenbrett	90x15x1800	4
9		Sandkastenbrett	90x15x900	4
10		Boden	1800x900	1
11		Leiterbalken	90x20x1350	L+P.
12		Stahlwinkel		4
13		Seitenwand	1090x1100	1

